



PORSCHE



The new Taycan

Soul, electrified.



The models featured in this publication are approved for road use in Germany. Some items of equipment are available as extra-cost options only. The availability of models and options may vary from market to market due to local restrictions and regulations. For information on standard and optional equipment, please consult your Porsche Centre. All information regarding construction, features, design, performance, dimensions, weight and running costs is correct to the best of our knowledge at the time of going to print (02/2020). Porsche reserves the right to alter specifications, equipment and delivery scopes without notice. Colours may differ from those illustrated. Errors and omissions excepted. More information in various languages is available at www.porsche.com/BEV

Contents.

- 6 **Soul, electrified.**
- 20 **The Taycan**
- 24 Models
- 26 Design
- 36 Battery
- 38 Drive
- 40 Performance
- 46 Chassis
- 48 Assistance systems
- 50 **Charging**
- 58 **Porsche Connect**
- 66 **Personalisation**
- 78 **Technical data**



Discover the soul of the Taycan using the 'Porsche AR Visualizer' app. Wherever this symbol appears, you can unlock exciting digital content by activating the 'Scan image' function.



What makes an electric sports car the first all-electric Porsche?



A crest that lends
metal a soul.

A battery that stores goosebumps.

The Taycan carries a legacy that is reflected by performance. The latest drive technology ensures that its performance can be repeatedly reproduced: two permanent magnet synchronous motors (PSMs) catapult the Taycan Turbo S with up to 560kW (761PS) overboost with Launch Control from 0 to 100km/h in 2.8 seconds. With a standing start performance of 1.2g, it accelerates faster than the force of gravity for the first few metres – making it faster than a skydiver in free fall.

For CO₂ emissions, all-electric range, electricity consumption and efficiency class, please refer to page 83 onwards.





IONITY

IONITY

IONITY

IONITY

A cable with the power to fuel dreams.

The Porsche soul stands for performance. In every respect. As demonstrated by the Taycan, even when charging: its 800-volt architecture produces charge power of up to 270kW. In just five minutes¹⁾, the vehicle can be charged to enable a range of up to 100km (WLTP) under optimum conditions²⁾ and is always ready for whatever its driver has planned throughout the day: driving.

1) For Taycan Turbo S and Taycan 4S with Performance Battery. 5.5 min.

2) Optimum conditions: CCS speed charging pedestal with >270kW, >850V, battery temperature 30°C to 35°C and output state of charge 5%.

For CO₂ emissions, all-electric range, electricity consumption and efficiency class, please refer to page 83 onwards.

A wide-angle, low-perspective shot of the interior of a Porsche Taycan. The view is from the driver's side, looking towards the front passenger area. The steering wheel is black with the Porsche crest in the center. The dashboard is a wide, curved digital display showing various vehicle metrics and navigation information. The center console features a gear selector and handbrake. The interior is finished with dark leather and metallic accents. Through the windshield, a city street scene is visible with people walking and buildings in the background.

A display that portrays emotions.

The Porsche Advanced Cockpit of the Taycan is characterised by pioneering technologies and offers up to four displays. The fully digital curved display is the driver's main focus. But what really distinguishes the Taycan is the feeling behind the wheel: the familiarity of a Porsche coupled with the irresistible beating of your heart.



An air intake
that expresses
performance.

The soul of a Porsche is revealed not only by inner virtues, but also from the outside: like any Porsche, the Taycan also boasts features such as the typical flyline or pronounced wings in which noticeable 'aircurtains' have been integrated for the first time – characteristics that stand for functionality, aerodynamics and athleticism.



An ignition switch that heralds a new era.

Can you reinvent yourself while remaining entirely true to yourself? We firmly believe that it is possible, and have been doing this for 70 years. What all Porsche generations have in common is their soul – in the form of all the details that they incorporate. And so the new Taycan can also be started using the ignition switch on the left – entirely silently and without a key. Some revolutions are remarkably quiet.



The Taycan.

Its heart: electric.
Its soul: Porsche.

The Taycan is ready for the future, thanks to its innovative total concept. It is characterised by the features that have always been decisive for any Porsche: pure emotion and maximum driving pleasure.

As you approach the Taycan in your garage, nothing stands in the way of your personal driving experience. The vehicle is fully charged, already knows your destination – transferred in advance via the Porsche Connect app – has planned the appropriate route and is pre-air conditioned ready for you to climb in.

You are instantly greeted by the familiar Porsche feeling – coupled with the latest technologies. The Porsche Advanced Cockpit boasts a fully digital 16.8-inch curved display, integrated 8.4-inch centre console control panel and 10.9-inch central display. Here, under 'Notifications', you'll find constantly updated information that is relevant to you. If you prefer to focus all your senses entirely on the road ahead, simply switch to the minimised view and only driving-relevant content will be displayed, such as speed and driving mode. As pure as the sports car experience behind it.

Then you put your foot on the pedal – and the Porsche soul of the Taycan is revealed: two permanent magnet synchronous motors producing up to 460kW (625PS) in the Taycan Turbo S unleash their full power from the start and allow acceleration that can be repeatedly reproduced. The low centre of gravity ensures exceptional cornering that instantly sets your pulse racing – just as you would expect of a Porsche.

As well as design and performance, the focus is on comfort and range. If required, the car can plan an efficient route, and make long-distance journeys more comfortable. Speed charging options reduce downtime – you can charge your car on the road to achieve a range of up to 100km in just five minutes¹⁾ (WLTP) under optimum conditions²⁾, using the 800-volt architecture.

The intelligent Porsche Recuperation Management (PRM) is self-regulating or can be actively set by the driver – depending on the situation. Thanks to extremely efficient recuperation, valuable miles are also recovered while driving. For both sporty and efficient performance – as is typical of Porsche.

So nothing stands in the way of your next jaunt.

1) For Taycan Turbo S and Taycan 4S with Performance Battery: 5.5 min.
2) Optimum conditions: CCS speed charging pedestal with >270kW, >850V, battery temperature 30°C to 35°C and output state of charge 5%.

For CO₂ emissions, all-electric range, electricity consumption and efficiency class, please refer to page 83 onwards.



A day in the Taycan.



Models.

For CO₂ emissions, all-electric range, electricity consumption and efficiency class, please refer to page 83 onwards.

Taycan Turbo

- Up to 460kW (625PS)
- Up to 500kW (680PS) Overboost Power with Launch Control
- 850Nm maximum torque with Launch Control
- 0 to 100km/h in 3.2 seconds with Launch Control
- Top speed of 260km/h
- Performance Battery Plus

Taycan 4S

- Up to 320kW (435PS)
- Up to 390kW (530PS) Overboost Power with Launch Control
- 640Nm maximum torque with Launch Control
- 0 to 100km/h in 4.0 seconds with Launch Control
- Top speed of 250km/h
- Performance Battery (optional Performance Battery Plus)

Taycan Turbo S

- Up to 460kW (625PS)
- Up to 560kW (761PS) Overboost Power with Launch Control
- 1,050Nm maximum torque with Launch Control
- 0 to 100km/h in 2.8 seconds with Launch Control
- Top speed of 260km/h
- Performance Battery Plus

Visit www.porsche.com/taycan-highlights to watch the Taycan launch film

Puristic, expressive, timeless. Three attributes that describe every Porsche – and especially this one, which takes our DNA into a new automotive era.

The all-electric drive structure of the Taycan provides additional space that we have consistently exploited. The compact size of the electric drive allows an extremely flat bonnet design, resulting in the flat bonnet and pronounced wings that are typical of Porsche.

Lateral air intakes ahead of the front wheels – so-called air curtains – also improve the aerodynamics,

by guiding incoming air over the wheels like a curtain, thereby reducing turbulence.

Directly above these is the highlight of the front-end: four-point LED headlights with matrix beam that combine all the light functions in a single component and appear to be floating.

The silhouette is characterised by a dynamic, flat flyline. Flush, **automatically extending door handles** open the vehicle interior with its deep, sporty seating position.

There are two roof options: the contoured variant made of lightweight aluminium with an indentation in the middle creates a shape that is known to us from motorsport. Alternatively, a **panoramic fixed glass roof** provides an open, airy feeling.

The rear design features a seamless light strip made of glass, as well as the **'PORSCHE' logo with glass look**. Above these are the **Porsche Active Aerodynamics (PAA)** in the form of a three-stage rear spoiler system.

The cabin tapers backwards and the rear wings are extremely pronounced, as is typical of Porsche. And because there is no exhaust system, the Taycan does not need any tailpipes: leaving more room for a seamless rear diffuser with a sporty, slatted design. A car that reflects the future – and yet instantly reveals the Porsche soul.



Exterior design.

Visit www.porsche.com/taycan-design to watch the design film.



Interior design.

1 Luggage compartment, front
2 Luggage compartment, rear

From the outside, it is a mere formality to quickly identify a Porsche as such. And in the interior, you can also sense distinctive Porsche genes in the new Taycan. The basic features of the interior architecture are sporty, minimalist and clear; the wing extending from the centre console immediately catches your eye and appears to be floating. The innovative cockpit displays are clearly driver-oriented, allowing you to keep an eye on the most important information, even during dynamic driving.

The seat position in the Taycan is derived from the 911. Optionally available in 14¹⁾ and 18 way²⁾ configurations, for maximum adjustability and comfort. Recesses in the design of the battery integrated into the underbody also ensure an adequate level of comfort for rear passengers.

Behind the wheel, you feel that the Taycan has been tailor-made for you. While your front and rear passengers enjoy an equally comfortable, sporty ride on lightweight seats with solid lateral support. On request, your Taycan can also be fitted with a 4+1 seating configuration.

As well as the 81-litre luggage compartment at the front for smaller items, the rear boot also provides 366 litres³⁾ of storage space that can be flexibly expanded, thanks to the individually folding rear seat backrests. In other words: the Taycan is, of course, a sophisticated electric sports car. And yet, like all its predecessors, totally suitable for everyday use.

1) Standard on the Taycan Turbo.
2) Standard on the Taycan Turbo S.
3) 407 litres in the Taycan 4S.

Driving a Porsche is always an emotional experience. To make this feeling even more personal, you can lend your car your own individual touch when it leaves the factory, using a selection of materials. In the interior, you can choose between **smooth-finish leather**, naturally treated **Olea club leather** and a sustainable, **leather-free interior** in various colours. We also offer aluminium, carbon or dark paldao open-pored wood interiors. Accent packages enable selected interior details to be personalised, thereby giving your vehicle an individual signature. The carpet and other interior elements are made of sustainable Econyl yarn. This is recycled fibre that is manufactured from used fishing nets, among other things.

On request, the Taycan also comes with **ambient lighting** that illuminates the interior. You can, of course, adjust the colour and brightness to your taste.

If the standard **multifunction sports steering wheel** is not sporty enough, you can maximise the motor-sport feel with the optional **multifunction GT sports steering wheel¹⁾**: it features a mode switch, as well as a top centre marking.

The innovative **Advanced Climate Control** air conditioning (dual or four-zone) may not be visible, but is certainly noticeable – the logical evolution of traditional automatic climate control systems. Slat-free air outlets are electrically controlled via Porsche Communication Management (PCM) including Online Navigation, enabling precise airflow and distribution.

The optionally available sound systems in the Porsche Taycan are further evidence of the fact that the power of electrical energy can evoke emotions: the **BOSE® Surround Sound System²⁾** with a total output of 710 watts provides entertainment in the interior. While the **Burmester® 3D High-End Surround Sound System** Morgen with 1,455 watts and 21 loudspeakers including an active subwoofer ensures exquisite musical delight while driving.

The Porsche feeling in every seat – for all your senses, as soon as you climb in.

1) In conjunction with Sport Chrono Package; available as standard in the Taycan Turbo S.

2) Standard on the Taycan Turbo and Taycan Turbo S.



21

Burmester® loudspeakers

3D

high-end surround sound

1,455

watts

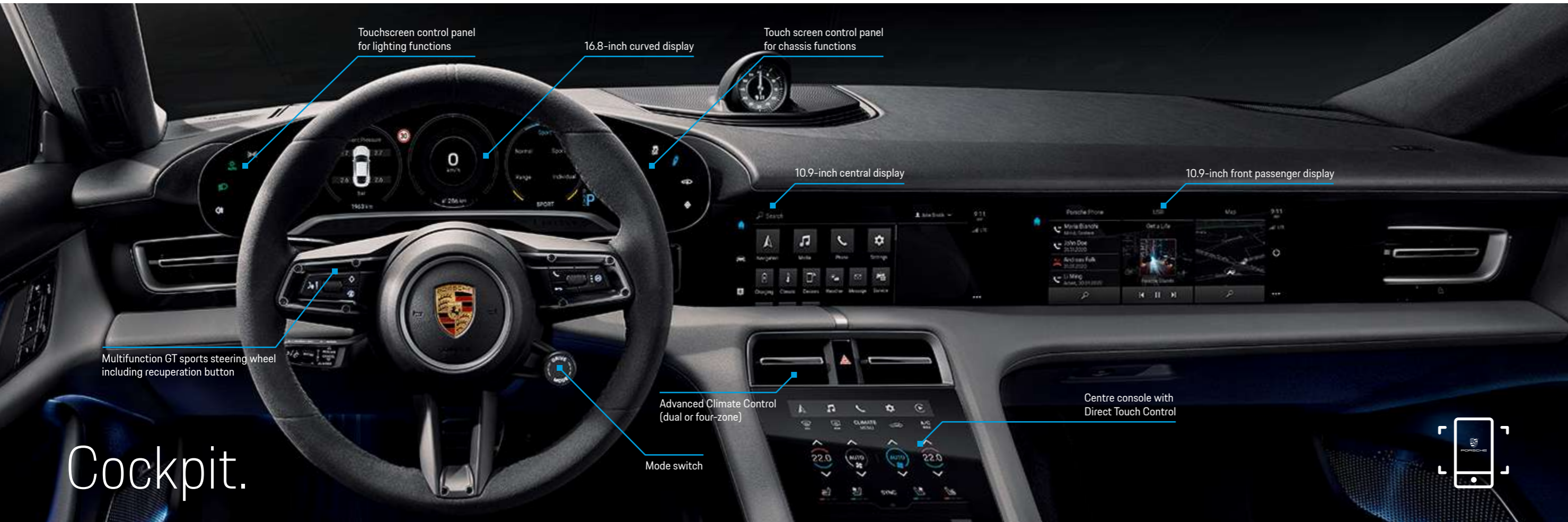

Touchscreen control panel for lighting functions

16.8-inch curved display

Touch screen control panel for chassis functions

10.9-inch central display

10.9-inch front passenger display

Multifunction GT sports steering wheel including recuperation button

Advanced Climate Control (dual or four-zone)

Mode switch

Centre console with Direct Touch Control

Cockpit.

We call the Taycan cockpit 'Advanced', because it has many pioneering features. It uses technology to increase its simplicity – while providing inspiration.

Mechanical buttons have been almost entirely replaced by digital ones. This makes the interior look extremely tidy. The same principle of tidiness also applies to the displays, of which there are up to four – intuitive, distraction-free and easy to use. As you would expect of a Porsche. Simply climb in, select the D setting and drive off. If you prefer to start your Taycan manually, the ignition switch is on the left – because here too, we are remaining true to our roots.

The arrangement is also driver-focused, as is typical of Porsche: the instrument cluster is the centre of attention, consisting of a **16.8-inch curved display** and surrounded by control panels with Direct Touch Control for selecting lighting and chassis functions. It is angled and concave – and thus one of the first exposed curved displays to be installed in a car. This instrument cluster houses three freely configurable round instruments: recognisably Porsche, but in virtual form. Alternatively, you can choose from up to five displays: including an advanced full-HD map, power meter and minimised view.

Your central control unit for audio, navigation and communication: redesigned **Porsche Communication Management (PCM)** including online navigation. The PCM display on the **10.9-inch central display** on the dashboard can be individually configured, allowing direct access to the most important functions. The navigation module features a clear interface – and innovative functions such as **route monitor**, which displays and summarises all the details of the route in a concise timeline, as well as scheduled charging points and any congestion.

Another new feature: main context notifications. Incoming notifications from connected devices or the vehicle are gathered and sorted here. As soon as the situation allows, you can retrieve a bundle of these – or simply have them read out. So you are always up to date.

Another digital element is located in the centre console, namely the **8.4-inch centre console control panel**. This provides access to navigation, media,

telephone, settings and Apple CarPlay via a menu bar which can be disabled. The rear luggage compartment and charge port doors (depending on the equipment) can also be opened and closed from here and the charging screen showing the battery charge status.

Depending on the specification of your Taycan, ParkAssist including Surround View and SPORT mode can also be activated and deactivated in the control bar.

Equally convenient is the enhanced **voice control**, which can be operated using native speech recognition in the Taycan. Voice control can be enabled by the “Hey Porsche” prompt, for example. And for the first time, you can also interact with it in a multimodal manner: simply tap the map in the central display and say “Take me there”, for example.

In addition, the Taycan comes with an optional **10.9-inch front passenger display**, allowing access

to navigation and infotainment functions, among other things. The front passenger can help with route planning or gain insight into data from the instrument cluster via the special Cockpit tile. For passengers in the back seats, an optional **5.9-inch rear passenger touchscreen display** is available. It also has a touch-sensitive surface, which can be used to operate comfort features, such as temperature, ventilation and seat heating.



- 1 5.9-inch rear passenger touchscreen display
- 2 16.8-inch curved display with three personalisable round instruments
- 3 10.9-inch central display
- 4 8.4-inch large centre console control panel
- 5 10.9-inch front passenger display including Cockpit tile



Interaction.

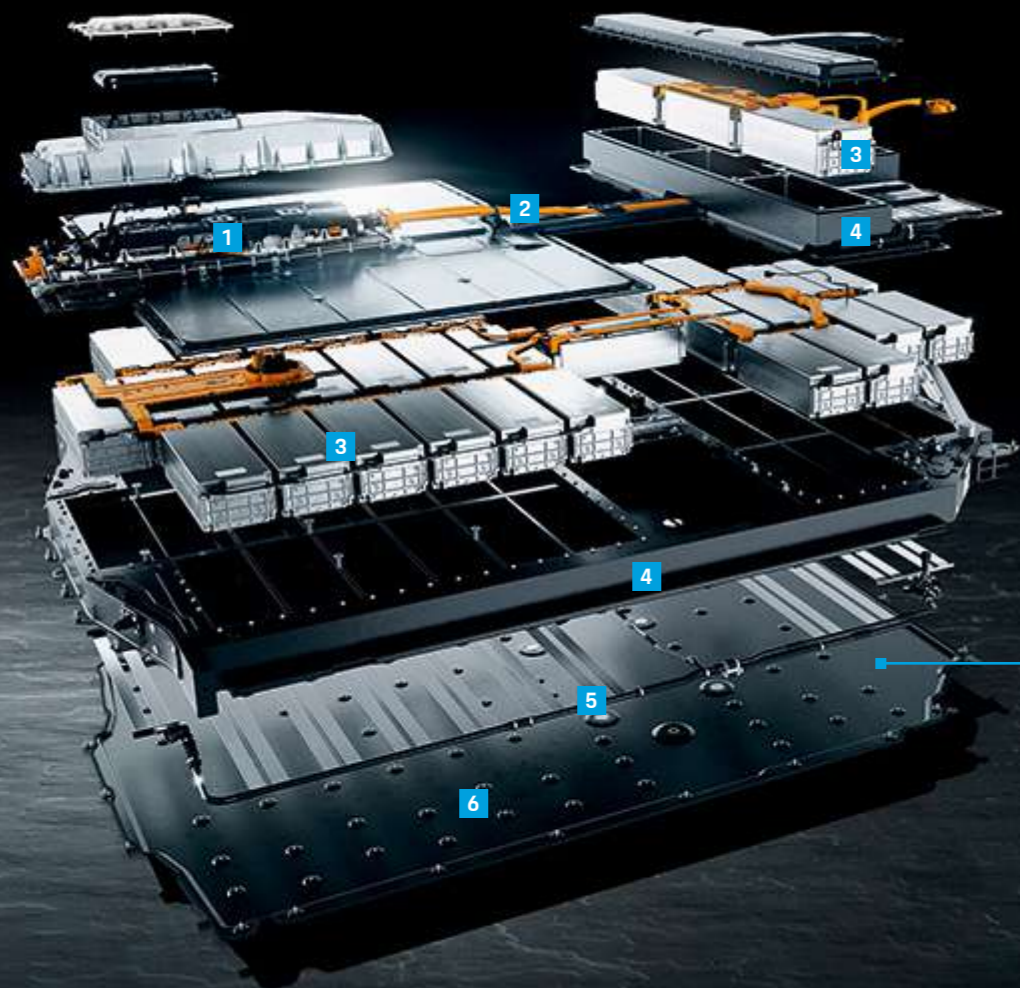

- 1 Battery management system
- 2 High-voltage cabling
- 3 Cell module
- 4 Battery frame
- 5 Cooling system
- 6 Protective plate

Battery.

The key to the Taycan is its powerful Performance Battery based on the latest lithium-ion technology – both energetic and static. It is integrated flush with the underbody, and the entire vehicle has been built around it – clearly demonstrating our purpose-design approach. The low centre of gravity and individual drives on the front and rear axle lead to optimum weight distribution and driving stability. The low seating position is similar to that in the Porsche 911. The battery also has practical recesses – for comfortable, sporty rear seats and a flat vehicle flyline.

The Taycan battery exploits its huge potential by means of pouch cells, chemically optimised for maximum performance with a long range: 33 modules with a total of 396 cells are available in the large version (Performance Battery Plus) and 28 modules with a total of 336 cells in the more compact variant that is fitted as standard in the Taycan 4S.

The battery is also based on 800-volt technology instead of the usual 400 volts. The effect: improved charging and drive performance with smaller cable cross-sections, which has a positive impact on the overall weight. The cooling system ensures that the drive is optimally supplied with energy in any situation. And an extremely robust battery frame ensures maximum safety even in the event of an accident.

The new battery technology at the heart of your Taycan has many advantages for you and your Taycan: high performance combined with a long range.

For CO₂ emissions, all-electric range, electricity consumption and efficiency class, please refer to page 83 onwards.

What applied to the legendary model 356 from 1948, applies even more so to the new Taycan: a vehicle concept that reflects changing automotive times requires a soul with the prestigious Porsche title.

The key to designing an outstanding drive was the systematic continuation of the purpose-design approach: no compromises with the perfect interaction of drive components. Two **permanent magnet synchronous motors** are therefore installed in the Taycan 4S, Taycan Turbo and Taycan Turbo S – one on each axle – and the Performance Battery is integrated deep into the underbody. The effect: superior driving dynamics and all-wheel drive that can be optimally adjusted to the fluctuation between efficiency and dynamics in the various driving modes.

The permanent magnet synchronous motor concept provides high power density coupled with high efficiency. In this type of electric motor, permanent magnets in the rotor of the electric motor generate

a natural magnetic field. Together with the so-called hair-pin technology in the stator, which enables greater copper fill levels and more effective cooling, a compact design, low weight and high efficiency can be achieved. High efficiency benefits both the range and continuous output of the drive.

A newly developed, automatically switching **two-speed transmission** on the rear axle ensures noticeably improved dynamics. The extremely short-ratio first gear benefits initial acceleration, while the long-ratio second gear holds acceleration reserves for high-speed manoeuvres.

The interaction of the drive components results in impressive performance figures, both technically and emotionally: when up to 560kW (761PS) Overboost Power with Launch Control is activated, both machines accelerate the Taycan Turbo S from a standstill to 100km/h in 2.8 seconds. Allowing you to experience a standing start performance on a par with that of a super sports car such as the

918 Spyder – that can be repeatedly reproduced: consecutive acceleration is possible, up to a top speed of 260km/h.

This is E-Performance, as can only be found in a Porsche.

For CO₂ emissions, all-electric range, electricity consumption and efficiency class, please refer to page 83 onwards.

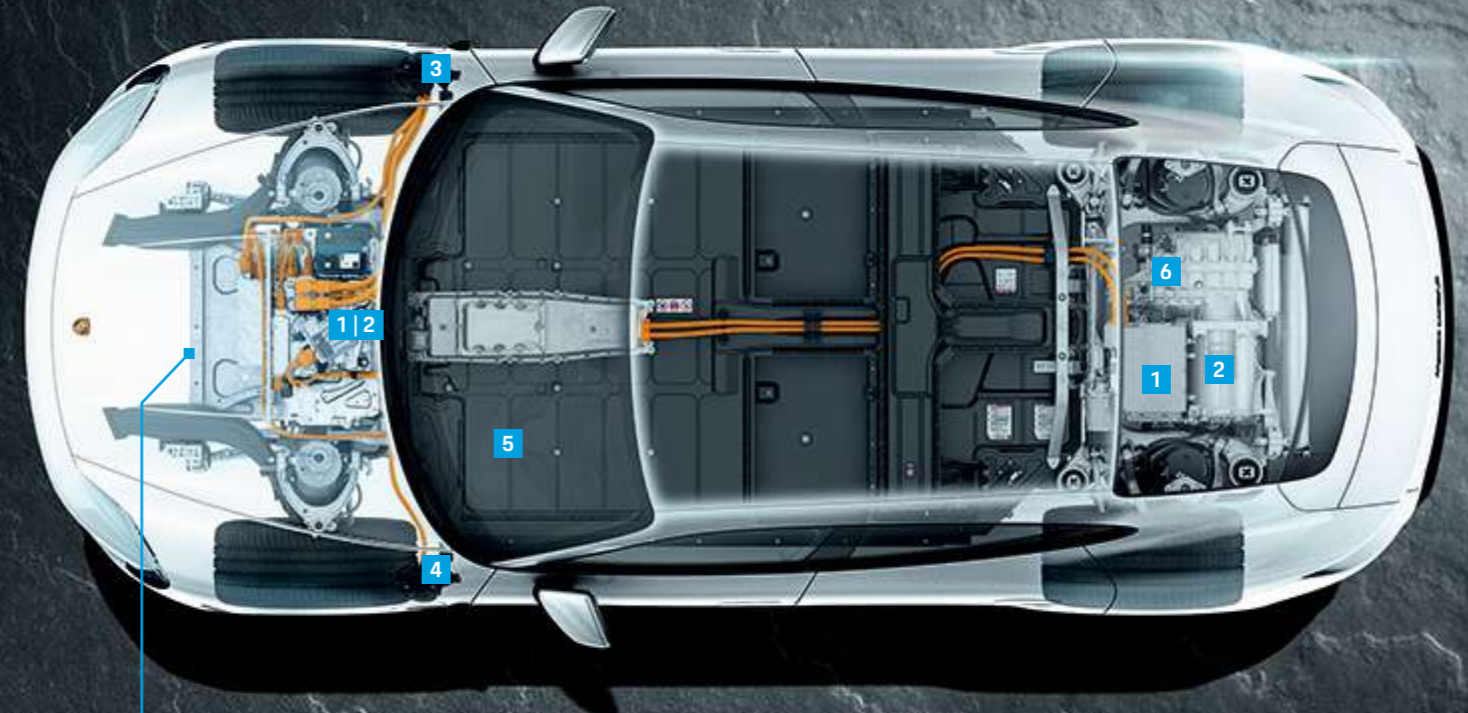

- 1** Power electronics
- 2** Permanent Magnet Synchronous Motor
- 3** Vehicle charge port (AC/DC)
- 4** Vehicle charge port (AC)
- 5** 800-volt Performance Battery Plus
- 6** Two-speed transmission



Drive.



Performance.

The Taycan is designed to be comfortable at any speed. And because it is a Porsche, it has intelligent systems to ensure that its driver is equally comfortable.

Adapt your car to your requirements, by selecting one of four driving modes. You can use these to optimally adjust various vehicle systems such as the air intake flaps, rear spoiler, thermal management, drive or chassis for every situation.

In **Normal** mode, the car achieves a perfect balance between efficiency, comfort and dynamics. The driving mode for all those who don't wish to select a driving mode.

In **SPORT** mode, the systems are set for enhanced emotionality and performance. The suspension and damping rate are essentially set for sporty driving, battery cooling is intensified and the chassis becomes firmer.

If you select **SPORT PLUS**¹⁾, the systems are honed even further. The chassis descends to its lowest level, the front air intake flaps open on demand and other systems, such as the rear-axle steering or chassis, are primed for maximum performance.

In **Individual** mode¹⁾, the vehicle settings can be combined, based on Normal, SPORT or SPORT PLUS modes.

The **Launch Control** function also produces maximum acceleration from a standing start. It can be activated in both SPORT and SPORT PLUS mode to prepare all systems for a racing start – and delivers incredible power to the tarmac: in the first 2.5 seconds, the Taycan Turbo S covers more ground than a 918 Spyder.

In **Range** mode, the entire vehicle is tuned for maximum efficiency. It starts in second gear – as in Normal mode. In addition, top speed is limited and the air conditioning is turned down, although you can modify individual settings, of course.

¹⁾ SPORT PLUS and Individual modes are part of the Sport Chrono Package, standard on the Taycan Turbo S.

For CO₂ emissions, all-electric range, electricity consumption and efficiency class, please refer to page 83 onwards.



1



The Taycan is fitted with the **Porsche Active Aerodynamics** system, consisting of an adaptive rear spoiler and adjustable cool air intakes, specifically for dynamic driving. Depending on the situation, the rear spoiler extends in three stages: at 90km/h, 160km/h and 200km/h, it demonstrates where an electric vehicle becomes a sports car and a sports car becomes a Porsche. The final stage (Performance) ensures maximum driving stability and optimum dynamic potential – ideal for fast lap times on the race track.

Regulated air intake flaps allow an optimum balance between aerodynamics and the cooling of the brakes and drive. This reduces air resistance, thereby improving the range. In the Taycan Turbo, the result is a remarkable drag coefficient of 0.22, which can be achieved in Range mode and at low level, with the air intake flaps closed.

The alloy wheels are also aerodynamically optimised. Depending on the model, standard 19-inch, 20-inch or even 21-inch wheels have a decisive impact on the design.

On request, your Taycan decelerates thanks to the **Porsche Surface Coated Brake (PSCB)** with white brake calipers – fitted as standard on the Taycan Turbo. An exclusive tungsten carbide coating optimises the brake's responsiveness and diminishes its susceptibility to wear, while the formation of brake dust is significantly reduced.

Or choose the extremely lightweight **Porsche Ceramic Composite Brake (PCCB)** – standard on the Taycan Turbo S. Our high-performance brake has its origins in motorsport and enables short braking distances in even the toughest conditions.

Acoustically too, the Taycan provides an entirely new experience: it makes virtually no noise – all you can hear is the exterior sound that meets the legal requirements. For a unique acoustic accompaniment to dynamic driving, there is also the optional **Porsche Electric Sport Sound** – a system whose innovative character makes the vehicle's own drive sound appear even more emotional, both outside and inside. The ideal feedback for your right foot.



2



3

- 1 Rear spoiler, extended
- 2 Porsche Ceramic Composite Brake (PCCB):
brake disc diameter 420mm front and 410mm rear
- 3 20-inch Taycan Turbo Aero wheel

Visit www.porsche.com/taycan-sound to experience Porsche Electric Sport Sound.

A Porsche is always a sports car – and should therefore be optimised for both sporty performance and maximum tenacity. We also considered this when designing the recuperation process, i.e. the efficient recovery of braking energy. In this case, the electric motors act as generators if required, resulting in deceleration.

For recuperation in the Taycan, we developed **Porsche Recuperation Management (PRM)**, which works innovatively and can regenerate up to 90% of braking energy. Thus, during active braking, recuperation is enabled first and the mechanical brake is only engaged when stronger braking is required – intelligently controlled by a braking system that is capable of blending.

So you significantly improve your car's staying power and some of the kinetic energy is transformed into additional miles of driving pleasure: with an outstanding recuperation output of up to 265kW, energy can be fed back into the battery in the Taycan.

Or to be more precise: during sporty, everyday driving, for example, you will achieve up to a third of your range exclusively from recuperation. With recuperation braking from 200km/h to 0, electrical energy can be recovered for a range of up to 4km.

In addition to the brake pedal, we have also included the accelerator pedal in PRM, optimally combining sporty driving with efficiency. The three recuperation modes can be conveniently adjusted via a button on the steering wheel, for maximum control and personalisation.

If you turn the system off, recuperation via the accelerator pedal is disabled and the Taycan is able to cruise, making efficient use of the kinetic energy. When the system is on, there will be moderate deceleration as soon as you take your foot off the accelerator pedal. In 'Auto' mode, deceleration occurs automatically – innovatively controlled using positioning sensors, when a slower vehicle is travelling in front of you, for example.

For CO₂ emissions, all-electric range, electricity consumption and efficiency class, please refer to page 83 onwards.



1 Recuperation button on the steering wheel for selecting recuperation stages

Recuperation.

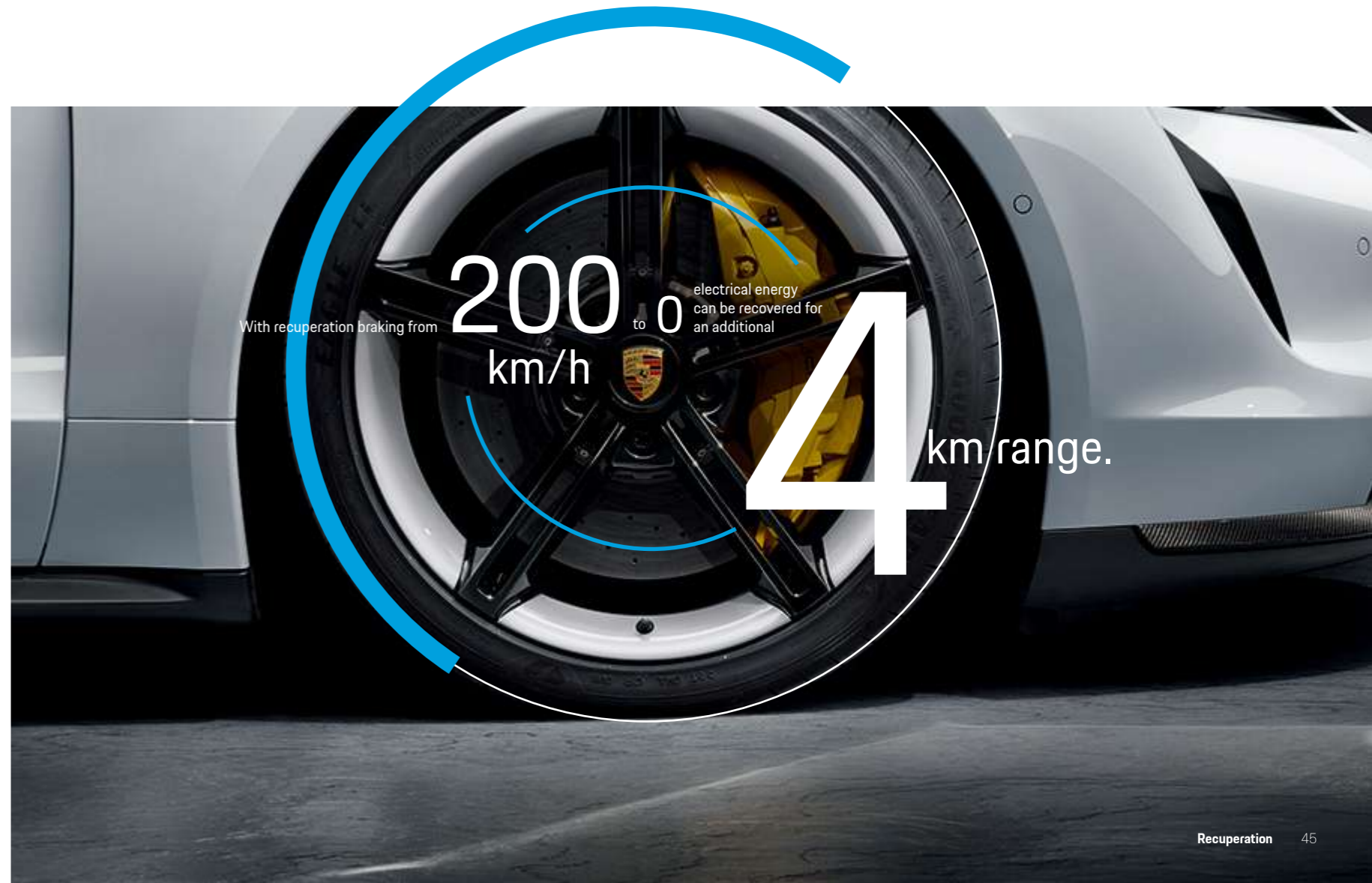

As with any Porsche, the chassis is also the supreme technical discipline in the Taycan. It uses all the Porsche chassis technologies to harmonise performance and comfort. The low centre of gravity due to the underbody battery is a distinct advantage when it comes to handling.

Intelligent chassis systems help it to transfer its potential to the road. Most of these have already been proven in other Porsche models.

Adaptive air suspension ensures a balance between comfort and performance. For optimum aerodynamics and, last but not least, an improved drag coefficient: increased range with maximum performance.

The chassis with **Porsche Active Suspension Management (PASM)** provides additional stability: an electronic damping control system that adjusts

the damping force, based on current road conditions and your driving style. This prevents annoying body roll and improves comfort in all seats.

Rear-axle steering steers the rear wheels in the same or the opposite direction to the front wheels, depending on the speed. This has the virtual effect of shortening or extending the wheelbase – depending on the situation. For increased stability at high speed, improved lateral acceleration on country roads and a reduced turning circle in everyday situations.

The roll stabilisation of **Porsche Dynamic Chassis Control Sport (PDCC Sport)** also ensures sporty dynamics. This system, which is also used in other model ranges, almost entirely offsets lateral body inclination, thereby allowing the wheels to hold the road better. It also reduces lateral instability on uneven ground.

Porsche Torque Vectoring Plus (PTV Plus) enhances driving dynamics and stability. Depending on the steering angle and driving speed, accelerator pedal position, yaw rate and speed, it improves the steering behaviour and accuracy by precisely and agilely applying brake pressure to the left or right rear wheel. At high speeds and when accelerating out of corners, the electronically controlled rear differential lock with fully variable torque distribution also acts to provide greater driving stability and traction.

To ensure that these systems interact perfectly, we have developed **Porsche 4D Chassis Control**: an integrated chassis control system that directs and synchronises the control units of the individual chassis components – for optimally balanced power electronics in every situation.

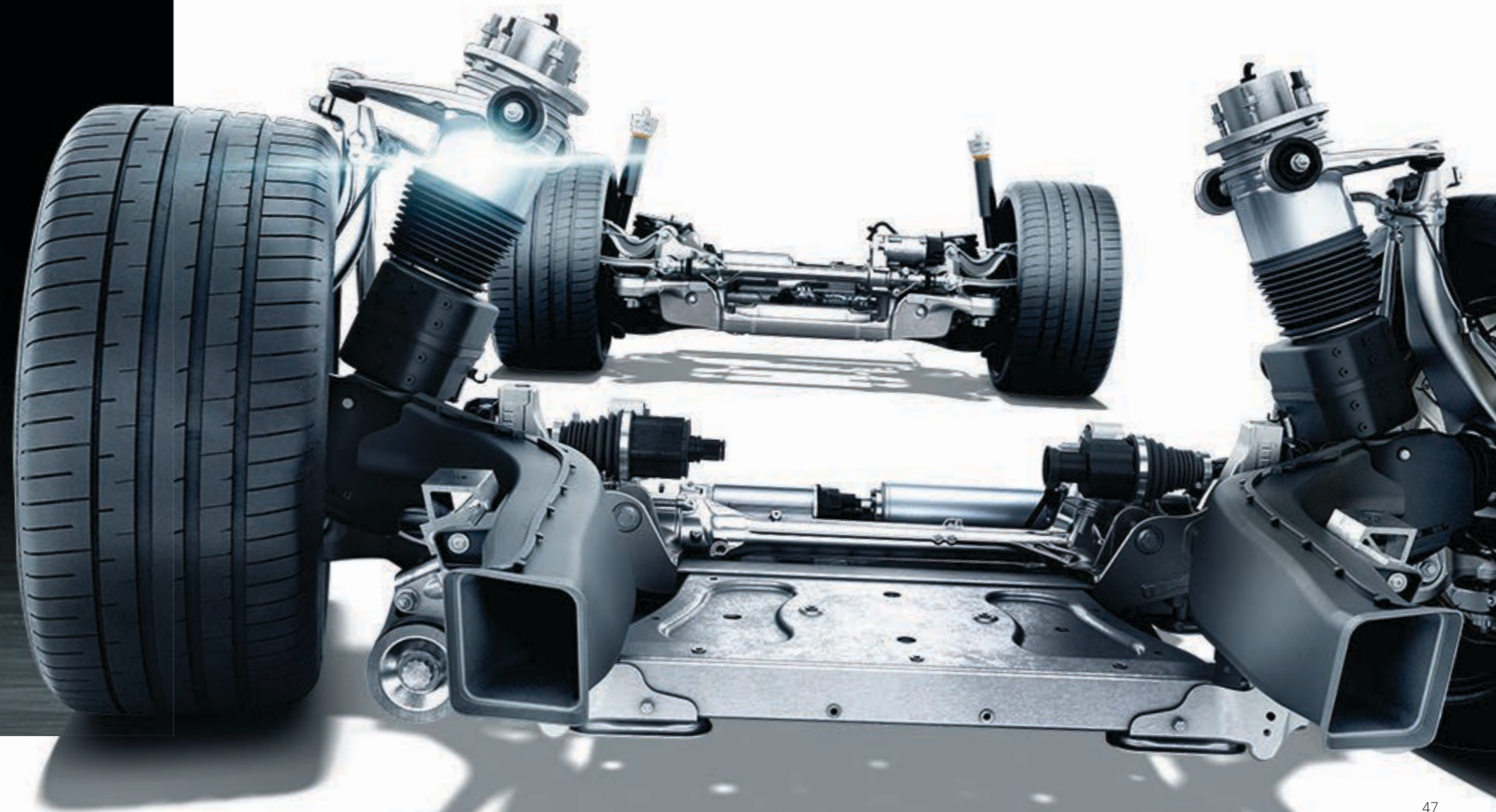

Chassis.

Driving a sports car means being able to fully focus on the driving experience. While being confident that nothing will tarnish this.

Adaptive cruise control (ACC) automatically adjusts the distance from the vehicle ahead – for added comfort on country roads and motorways.

As part of intelligent **Porsche InnoDrive including adaptive cruise control**, the system increases the prediction horizon to up to 3km. With the aid of navigation data and information supplied by the radar and video sensors, it determines speed limits and topographical road features long before you reach them and modifies the speed and gearshift strategy to suit the selected driving mode. All according to Porsche standards. So you get more driving pleasure and efficiency from every metre.

Active Lane Keeping, which uses longitudinal and lateral control to help keep the Taycan in lane and regulate the distance from vehicles in front, is also an integral part of this system – as is **Traffic Jam Assist**, which keeps the vehicle in the middle of the lane on congested roads, for greater comfort on longer journeys.



Lane Change Assist indicates whether a vehicle is in your blind spot as you move to change lanes – extremely practical when driving on the motorway. And at night, **Night Vision Assist** uses an infrared camera to provide support – pedestrians and wild-life are displayed as thermal images and also highlighted in colour.

Porsche Entry & Drive allows you to leave your car key in your pocket, by recognising the encrypted access code stored on the key. The Taycan can be conveniently started using the electric power button

to the left of the steering wheel or by simply selecting a gear.

Surround View ensures optimum care when parking and manoeuvring using one hand. Making every metre in the Taycan a driving experience – regardless of the speed.



Assistance systems.



Charging.

Top speed.
Even when at a standstill.

In terms of charging time and range, the Taycan also demonstrates what makes a genuine Porsche. Because we believe that a sports car should be ready to set off at all times, we do our utmost to facilitate simple charging that is integrated into everyday life. Because the only thing you should think about is where to go next.

Our charging concept starts with the vehicle: the Performance Battery with the latest lithium-ion technology is based on 800-volt architecture and, therefore, on a similar system to our endurance race car, the 919 Hybrid. Higher voltage means not only perceptibly more power and less weight, thanks to reduced cable size, but above all shorter charging times.

Because we not only think about the product, but also about the environment in which it is used, Porsche is involved in the development of a nationwide charging infrastructure: both with its own solutions and together with partners – along motorways, for example.

Today, several thousand rapid charging options are already available around the world. In conjunction with the Porsche Charging Service, we will enable you to charge your vehicle at a constantly growing network of IONITY speed charging parks in a number of European countries for a period of three years, without paying the basic fee.¹⁾

Porsche Turbo Charging at selected Porsche Centres further expands the Porsche charging network. Here, you can charge your vehicle to achieve a range of up to 100km in five minutes²⁾ (WLTP) under optimum conditions³⁾. Thanks to the built-in 50kW DC charger (a 150kW charger is available as an option), you can also conveniently use public 400-volt charging stations.

Added to this are numerous alternating current (AC) charging options, at restaurants and hotels, for example, as well as in many city centres. You can conveniently use any charging point via the **Porsche Charging Service** (part of the Porsche Connect app).

All this makes your Taycan not only future-proof, but also suitable for everyday use.

- 1) Only via Porsche Charging Service at IONITY charging stations in Europe.
- 2) For Taycan Turbo S and Taycan 4S with Performance Battery: 5.5 min.
- 3) Optimum conditions: CCS speed charging pedestal with >270kW, >850V, battery temperature 30°C to 35°C and output state of charge 5%.

For CO₂ emissions, all-electric range, electricity consumption and efficiency class, please refer to page 83 onwards.



Charging concept.



Charging in your own garage is the most obvious solution for many, because it can easily be integrated into their everyday routine. To do this, all you have to do is open the **electric charge port door**¹⁾ and connect the charging cable to your car.

Use the standard **Mobile Charger Plus**²⁾ to charge the vehicle – connected to your mains supply. Or the optional intelligent **Mobile Charger Connect** with touchscreen. You can also conveniently attach the Mobile Charger Connect to your garage wall in the optionally available **Charging Dock**. The **Porsche Connect app** allows you to access information about the remaining charging time or battery charge.

Using the charging timer in your car's Porsche Communication Management (PCM) including Online Navigation, or the Porsche Connect app, you can specify a time at which your vehicle should be ready to depart the following day.

To enable you to quickly and easily charge your Taycan at home, we provide the **Porsche Home Energy Manager**: an intelligent control unit, installed in the power distribution box, which constantly communicates with your charger. It makes sure that your household electric appliances are supplied with sufficient energy while your car is being charged in the garage. This also allows you to make targeted use of your own solar power.

Of course, we will help you to organise an inspection of your electrical installation. For an initial assessment of your personal charging options, we recommend our **charging pre-check**. Your Porsche Centre will then be happy to answer any questions about your results and also provide the option of a detailed, on-site home check of your electrical installation.

Your Porsche Centre will be happy to answer any questions and help you to select a suitable installation partner.

1) Optionally available; standard on the Taycan Turbo S.

2) Available from mid-2020 at the earliest.

Charging at home.

Part of our DNA is to think not about vehicles, but about concepts. And thus, the Taycan concept does not end with the car – and not even at the city boundary: we already offer a network of several thousand charging facilities, together with partners such as **IONITY** and **Electrify America**. In addition, our network of efficient **Porsche Turbo Chargers** at Porsche Centres is steadily growing. You will already find these rapid 800-volt charging stations at many Porsche Centres, where the Taycan can be charged with up to 270kW. Added to this are thousands of public AC charging stations in city centres and at selected locations, such as luxury hotels and restaurants, thanks to the **Porsche Destination Charging Network**.

On the road, intelligent in-car systems assist with efficient range management. The **Charging Planner**¹⁾ will plan your forthcoming route, including charging stops, to ensure you have a comfortable journey with no complicated charging planning. Furthermore, you can use the **Porsche Intelligent Range Manager**, optionally available in selected countries, to precisely adapt relevant systems on long journeys with active

navigation, so as to minimise travel time, including charging stops. Among other things, your vehicle's top speed and air conditioning are adjusted so that you achieve maximum range with optimum comfort and the best possible performance. During your journey, the system also provides proactive advice, in case you can reduce your travel time with a different vehicle set-up, and suggests this set-up via a pop-up.

Thanks to the **Porsche Charging Service**, charging at public pedestals is even easier: the **Porsche Connect app** allows you to locate charging pedestals in many countries, start the charging process and pay your bill. There is no need to register with the respective provider. Charging is conveniently administered and invoiced via your **Porsche ID account**.

Current charging facilities can be accessed at any time via Porsche Communication Management in your Taycan or online at www.porsche.com/taycan-charging

¹⁾ Not available in all countries.

Charging on the road.





Porsche Connect.

A profound
connection to your car.



Porsche Connect.

Porsche Connect connects you to your Taycan and your Taycan to the world – before, during and after your journey. The system extends the existing vehicle functions with intelligent digital services and apps, and facilitates a personalised in-car Connect experience, thanks to the new registration process – even when it is used by several drivers.

For the first time, you can also purchase individual functions after taking delivery of your car – depending on its configuration – via **Function on Demand (FoD)** in the Porsche Connect Store.

The basis for Porsche Connect is the **LTE communication module**. It ensures an optimised data connection in your Taycan and to your smartphone or tablet. The new Porsche Connect Package including data allowance enables you to conveniently use all the services – including Internet radio and music streaming. In many countries, you can also purchase a data package to establish an Internet connection using your mobile devices.

In the Taycan, Porsche Connect has been expanded to include innovative services. Above all, **Voice Pilot**, which uses the keyword, “Hey Porsche”, to provide a natural, intuitive native speech recognition. Your car will respond to statements such as “I’m cold” and multimodal operation using both touch and voice commands is also possible: point to the map and say “Start navigation”, for example.

When on the road, **Navigation Plus** continually retrieves real-time traffic information, so that you can avoid traffic jams and save time. Relevant charging pedestals are synchronised for the **Charging Planner**¹⁾, which allows you to plan routes to more distant destinations, including charging stops, and continuously updates and optimises the route using your drive profile.

Charging pedestals are automatically selected and integrated into your route – and the residual energy, charging time and total travel time are displayed. This service can also be used via the Porsche Connect app. Charging pedestals and other destinations, such as restaurants or hotels, can be selected in real time via the **Finder**.



1 Navigation Plus

You can keep on eye on your route all the time you are driving, using the practical **route monitor**. This provides a clear overview of the relevant real-time traffic, charging planning and charging stop information – allowing you to fully focus on the pleasure of driving behind the wheel.

1) Not available in all countries.

Porsche Communication Management (PCM) in your Taycan allows you to use **Radio Plus**. This ensures constant musical enjoyment by combining the Internet radio integrated in PCM and the automatic, uninterrupted switching between FM/DAB/online radio sources.

In addition, it supports **Apple CarPlay** which is a smarter, safer way to use your iPhone in your Taycan. CarPlay lets you get directions, send and receive messages, and more on the built-in PCM or using Siri voice control — to stay fully focused on the road.

Another Taycan highlight introduces the seamless integration of **Apple Music** directly in the PCM. Simply tap on Apple Music to stream over 60 million songs ad-free and curated playlists for any driving mood. Or create your own custom station on Apple Music from any radio song. New Taycan owners receive up to 6 months free of Apple Music.¹⁾

Using **Car Control**, the Porsche Connect app also gives you the option to control important vehicle status information, such as locking the doors and tyre pressure, at any time. The **E-Control** service also provides information about E-mobility functions, such as charging status and current range, while you can also check the speed of the charging process in real time.

The app will notify you of status changes. If you have installed **Porsche Mobile Charger Connect** and **Porsche Home Energy Manager** at home, you can activate intelligent charging profiles and charge your car at a reasonable price, making optimum use of solar power. Determine the temperature of your Taycan even before setting off using the **Climate** service, which enables you to cool or heat the vehicle interior, even if your car is not being charged. Both functions can also be pre-programmed using the timer. The **Car Finder** then unerringly takes you to your car.

And just in case, your Taycan is protected by the **Porsche Vehicle Tracking System (PVTs)**, using an independent theft detection feature. More information about the Car Security Package is available in the Porsche Connect Store.

To make your future workshop visits even more efficient, we will soon be offering optional **online software updates** for your Taycan. So your car always has the latest software version.

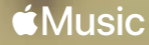

Your favourite music while on the road.

Conveniently listen to over 60 million ad-free songs in your Taycan.



¹⁾ Depending on country. Apple Music requires a subscription.

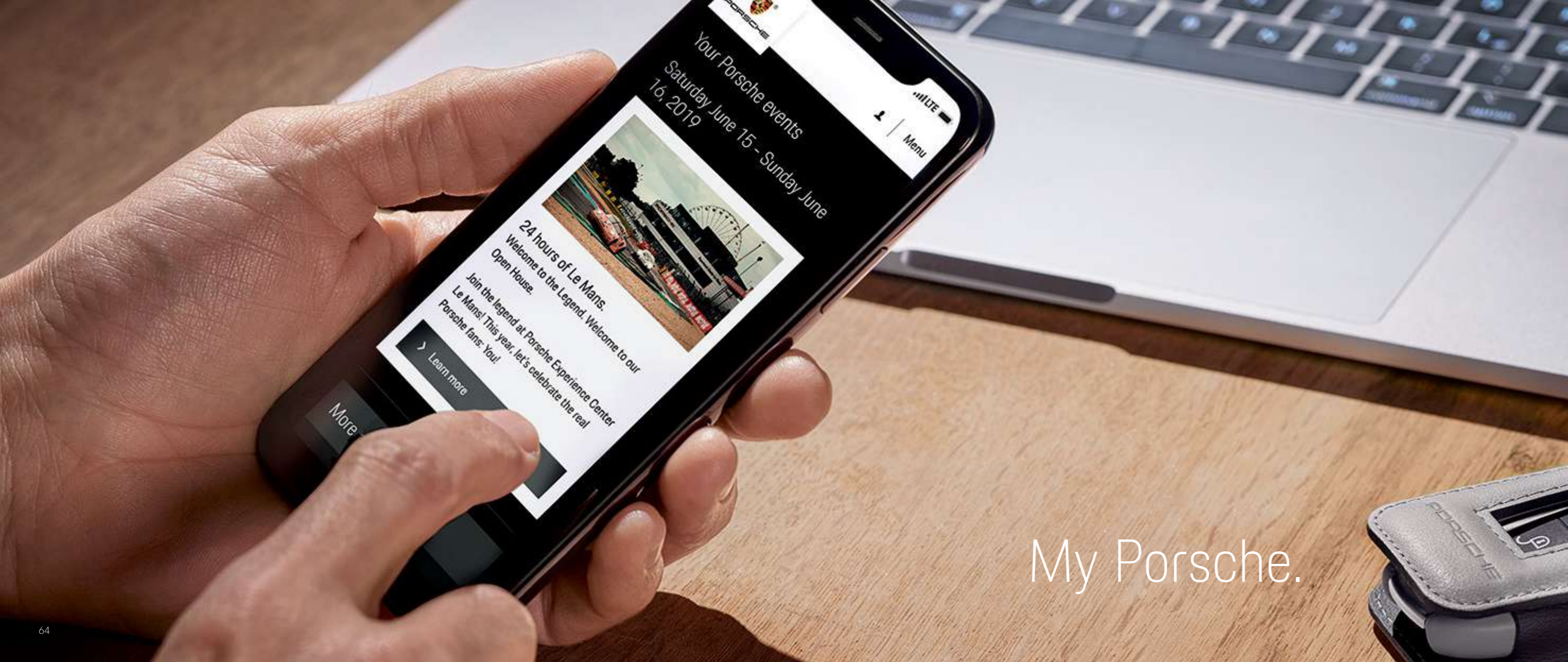

My Porsche.

The **Porsche Connect Package** and all services are included worldwide for three years. The functions are available after you purchase your car.

All the features of your Porsche Connect app integrate you and your Taycan into an all-encompassing ecosystem that lets you interact with your vehicle using multimedia. With the help of **My Porsche**, which provides online access to your Porsche Profile, you can access not only all the relevant information about your car, but also, for example, send the planned route to your car in advance or contact your Porsche Centre. You will receive your very own Porsche ID to use this service.

Your Porsche Connect services can also be easily configured. Visit the **Porsche Connect Store** and discover more about the functions and services. Extend your contract term or purchase additional services. Complete control of your Taycan – entirely in your hands.

All other information is available at www.porsche.com/connect



Personalisation.

Its soul.

Your signature.

Exterior colours.¹⁾

Solid colours.



White



Black

Metallic colours.



Jet Black Metallic



Volcano Grey Metallic



Carrara White Metallic



Gentian Blue Metallic



Dolomite Silver Metallic



Mamba Green Metallic



Frozenblue Metallic



Mahogany Metallic



Frozenberry Metallic



Cherry Metallic



Coffee Beige Metallic

Special colours.



Carmine Red



Neptune Blue



Crayon



Ice Grey Metallic

Interior.¹⁾

Partial leather interior.



Black



Slate Grey

Partial leather interior in two-tone combination.



Black and Chalk Beige

Leather interior, smooth-finish leather.



Black



Slate Grey



Blackberry

Leather interior in two-tone combination, smooth-finish leather.



Black and Bordeaux Red



Black and Chalk Beige



Black and Crayon



Blackberry and Slate Grey

Leather-free interior.



Black



Graphite Blue



Slate Grey

Leather-free interior in two-tone combination.



Black and Slate Grey



Graphite Blue and Slate Grey



Leather interior Olea club leather.



Truffle Brown

Basalt Black



Basalt Black



Leather interior Olea club leather in two-tone combination.

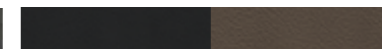

Basalt Black and Atacama Beige



Basalt Black and Meranti Brown

Interior packages.



Matt carbon
Porsche Exclusive Manufaktur



Rhombus aluminium



Dark paldao open-pored

Accent packages.



Black



Dark Silver



Neodyme



Painted in exterior colour
Porsche Exclusive Manufaktur

Colours.

¹⁾ For all available colours and interiors, please visit www.porsche.com/taycan-visualizer or your Porsche Centre.



3

Wheels.



1



4



6



2



5



7

- 1 20-inch Taycan Turbo Aero wheel
- 2 20-inch Sport Aero wheel
- 3 21-inch Mission E Design wheel painted in exterior colour
Porsche Exclusive Manufaktur
- 4 21-inch Mission E Design wheel painted in black (high-gloss)
Porsche Exclusive Manufaktur
- 5 21-inch Taycan Exclusive Design wheel
Porsche Exclusive Manufaktur
- 6 21-inch Taycan Exclusive Design wheel painted in satin Aurum
Porsche Exclusive Manufaktur
- 7 21-inch Taycan Exclusive Design wheel with carbon aeroblades
Porsche Exclusive Manufaktur

Other alloy wheels are available in the Porsche Car Configurator.



Personalise your car at any time after purchase with the Porsche accessories programme. The entire product portfolio is available online at www.porsche.com/finder

Tequipment.



Porsche Exclusive Manufaktur.

Your inspiration. Our passion.

Our wealth of experience goes back a long way. Since the very beginning, we at Porsche have been dedicated to realising customer wishes. Known until 1986 as the Porsche 'Sonderwunschprogramm', then 'Porsche Exclusive' – and today we call it Porsche Exclusive Manufaktur.

We love what we do. We love our work. Every seam, every square inch of leather, and every single other fine detail receives the same devotion. We transfer our experience and passion together with your inspiration to the car – and that's how we bring dreams to life. Directly from the Manufaktur.

None of this would be possible without originality, enthusiasm and attention to detail, beginning as early as the consultation stage. That's because we keep in mind one thing above all else: your particular wishes and requirements, turning 'a' Porsche into 'your' Porsche.

And how do we turn your dreams into reality? With composure and meticulous care, by means of precision handcrafting and the use of exquisite materials such as leather and carbon. Added value is achieved through dedication and finesse. Or to put it another way: the intersecting of sporty performance, comfort, design and your personal taste. A Porsche with your signature touch.

We offer a wide range of personalisation options, with visual and technical enhancements for the interior and exterior. From a single alteration to extensive modifications. Your inspiration is our passion.

Be inspired by our examples on the following pages and visit www.porsche.com/exclusive-manufaktur to learn everything you need to know about configuring these extraordinary vehicles.





21-inch Taycan Exclusive Design wheels with carbon aeroblades

Model designation on doors in black

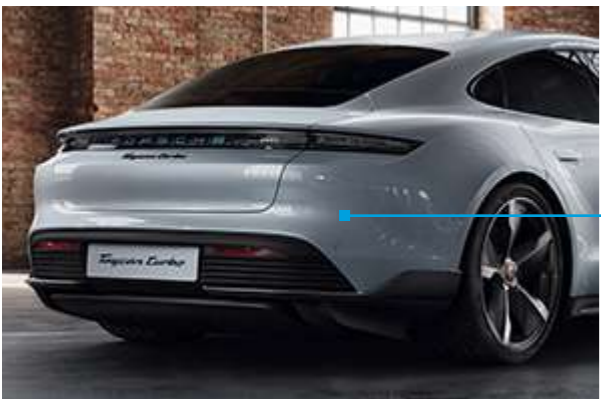

- Light strip with 'PORSCHE' logo in Glacier Blue¹⁾
- Model designation painted in black (high-gloss)
- Carbon SportDesign package²⁾

For CO₂ emissions, all-electric range, electricity consumption and efficiency class, please refer to page 83 onwards.

1) Provisionally available from 09/2020.
2) For Taycan Turbo and Taycan 4S, provisionally available from 06/2020.

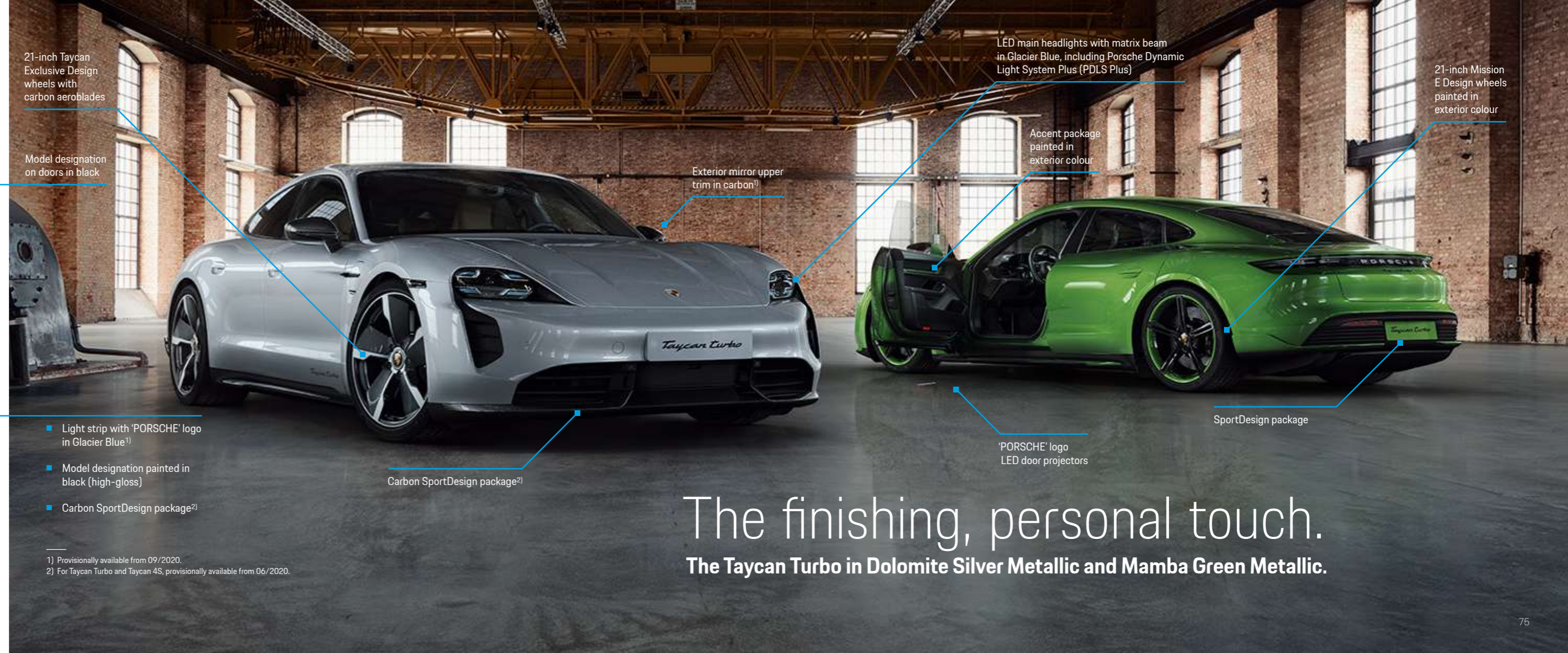

LED main headlights with matrix beam in Glacier Blue, including Porsche Dynamic Light System Plus (PDLS Plus)

Accent package painted in exterior colour

Exterior mirror upper trim in carbon¹⁾

21-inch Mission E Design wheels painted in exterior colour

SportDesign package

'PORSCHE' logo LED door projectors

Carbon SportDesign package²⁾

The finishing, personal touch.

The Taycan Turbo in Dolomite Silver Metallic and Mamba Green Metallic.



Steering wheel trim in matt carbon

Matt carbon interior package

Seat belts in Chalk Beige

'PORSCHE' logo on centre console storage compartment lid

Accent package painted in exterior colour

Porsche Crest embossed on headrests²⁾

Sport Chrono stopwatch instrument dial in white

Door sill guards in matt carbon, illuminated

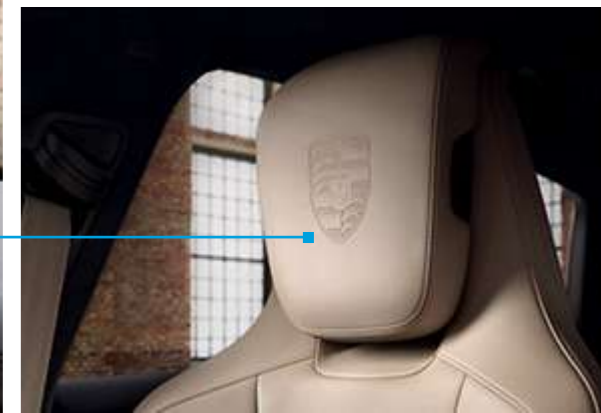

The Taycan Turbo with Black and Chalk Beige interior.¹⁾



1) The complete vehicle configuration is available at www.porsche.com/exclusive-manufaktur
 2) Provisionally available from 02/2020.

For CO₂ emissions, all-electric range, electricity consumption and efficiency class, please refer to page 83 onwards.

Technical data.

Not just one new standard.
Many.



Porsche E-Performance drive

Model	Turbo S	Turbo	4S	4S
Battery variant	Performance Battery Plus	Performance Battery Plus	Performance Battery Plus	Performance Battery
Electric motor, front axle	Permanent Magnet Synchronous Motor	Permanent Magnet Synchronous Motor	Permanent Magnet Synchronous Motor	Permanent Magnet Synchronous Motor
Electric motor, rear axle	Permanent Magnet Synchronous Motor	Permanent Magnet Synchronous Motor	Permanent Magnet Synchronous Motor	Permanent Magnet Synchronous Motor
Power (kW/PS)	Up to 460/625	Up to 460/625	Up to 360/490	Up to 320/435
Overboost Power with Launch Control (kW/PS)	Up to 560/761	Up to 500/680	Up to 420/571	Up to 390/530
Maximum torque with Launch Control (Nm)	1,050	850	650	640

Performance

Top speed (km/h)	260	260	250	250
Acceleration 0–100km/h with Launch Control (seconds)	2.8	3.2	4.0	4.0
Acceleration 0–200km/h with Launch Control (seconds)	9.8	10.6	12.9	13.3
Overtaking acceleration 80–120km/h (seconds)	1.7	1.9	2.3	2.3

Technical data.

Charging

Model	Turbo S	Turbo	4S	4S
Battery variant	Performance Battery Plus	Performance Battery Plus	Performance Battery Plus	Performance Battery
Gross battery capacity (kWh)	93.4	93.4	93.4	79.2
Net battery capacity (kWh)	83.7	83.7	83.7	71
Charging time for alternating current (AC) with 11kW (0–100%) (h)	9	9	9	8
Maximum charging performance for direct current (DC) (kW)	270	270	270	225
Charging time for direct current (DC) with 50kW for up to 100km (WLTP) (min)	31	28	28	31
Charging time for DC (direct current) with maximum charging performance for up to 100km (WLTP) under optimum conditions ¹⁾ (min)	5.5	5	5	5.5
Charging time for direct current (DC) with 50kW (5–80%) (min)	93	93	93	93
Charging time for DC (direct current) with maximum charging performance, from 5% to up to 80% under optimum conditions ¹⁾ (min)	22.5	22.5	22.5	22.5

1) Optimum conditions: CCS speed charging pedestal with >270kW, >850V, battery temperature 30°C to 35°C and output state of charge 5%.

Dimensions

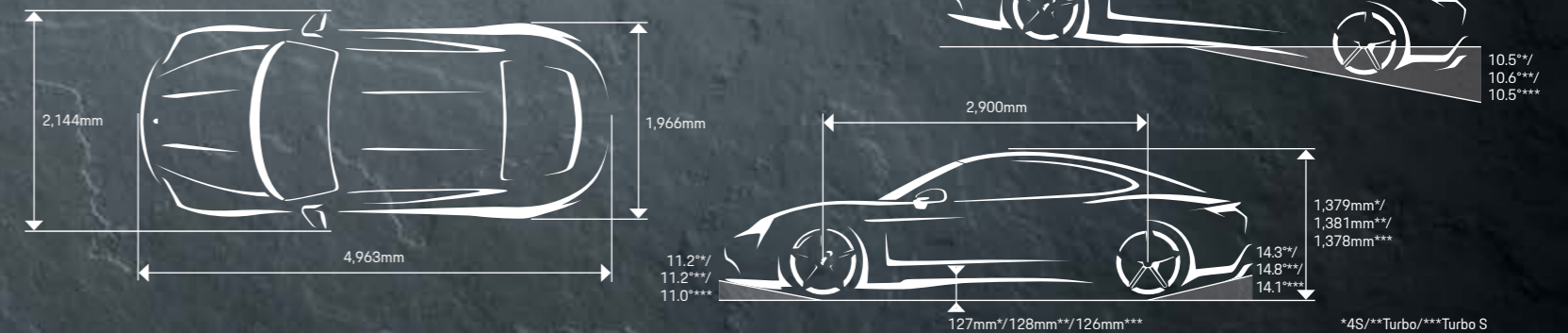

*4S/**Turbo/***Turbo S

Chassis

Model Battery variant	Turbo S Performance Battery Plus	Turbo Performance Battery Plus	4S Performance Battery Plus	4S Performance Battery
Turning circle diameter (m)	–	11.7	11.7	11.7
Turning circle diameter in conjunction with rear-axle steering (m)	11.2	11.2	11.2	11.2
Brake discs, front axle diameter/thickness (mm)	420/40	415/40	360/36	360/36
Brake discs, rear axle diameter/thickness (mm)	410/32	365/28	358/28	358/28

Weights

Unladen weight (DIN) (kg)	2,295	2,305	2,220	2,140
Unladen weight (EC) (kg) ¹⁾	2,370	2,380	2,295	2,215
Permissible total weight (kg)	2,870	2,880	2,880	2,880
Maximum permissible roof load with Porsche roof transport system (kg)	75	75	75	75

Volume

Luggage compartment, rear (litres)	366	366	407	407
Luggage compartment, front (l)	81	81	81	81

Range/fuel consumption/emissions²⁾

Model Battery variant	Turbo S Performance Battery Plus	Turbo Performance Battery Plus	4S Performance Battery Plus	4S Performance Battery
Range (WLTP) (km)	388–412	381–450	386–463	333–407
Range (long distance) (km) ³⁾	340	370	365	320
Electricity consumption (combined) (kWh/100km), petrol equivalent Switzerland (l/100km) ⁴⁾	26.9 3.0	26.0 2.9	25.6 2.8	24.6 2.7
CO ₂ emissions (g/km)	0	0	0	0
CO ₂ emissions from electricity supply, Switzerland (g/km) ⁴⁾	37	36	36	34
Efficiency class (Germany)	A+	A+	A+	A+
Efficiency class (Switzerland)	B	B	A	A





1) Weight is calculated in accordance with the relevant EC Directives and is valid for vehicles with standard specification only. Optional equipment increases this figure. The figure given includes 75kg for the driver.

2) Data determined in accordance with the measurement method required by law. Since 01 September 2017, certain new cars have been type approved in accordance with the Worldwide Harmonised Light Vehicles Test Procedure (WLTP), a more realistic test procedure to measure fuel consumption and CO₂ emissions. From 01 September 2018, the WLTP replaced the New European Driving Cycle (NEDC). Due to the more realistic test conditions, the fuel consumption and CO₂ emission values determined in accordance with the WLTP will, in many cases, be higher than those determined in accordance with the NEDC. This may lead to corresponding changes in vehicle taxation from 01 September 2018. You can find more information on the difference between WLTP and NEDC at www.porsche.com/wltp. Currently, we are still obliged to provide the NEDC values, irrespective of the testing method used. The additional reporting of the WLTP values is voluntary until their obligatory use. As far as new cars (which are type approved in accordance with the WLTP) are concerned, the NEDC values will therefore be derived from the WLTP values during the transition period. To the extent that NEDC values are given as ranges, these do not relate to a single, individual car and do not constitute part of the offer. They are intended solely as a means of comparing different types of vehicle. Extra features and accessories (attachments, tyre formats, etc.) can change relevant vehicle parameters such as weight, rolling resistance and aerodynamics and, in addition to weather and traffic conditions, as well as individual handling, can affect the fuel consumption, electricity consumption, CO₂ emissions and performance values of a car.



3) Guide value determined in accordance with a partial WLTP cycle (including allowing for auxiliary equipment such as air conditioning)

4) The average CO₂ emissions value of all new vehicles sold in Switzerland is 137g/km.

Tyres

Tyre type	Size	Fuel efficiency class/ rolling resistance	Wet grip class	External rolling noise ¹⁾ (class)	External rolling noise (dB)
Summer tyres					
	225/55 R 19	B	B		72
	275/45 R 19	B	B		73
	225/55 R 19	B	A		71
	275/45 R 19	B	A		72
	225/55 R 19	B	A		71
	275/45 R 19	B	A		71
	245/45 R 20	B	A		71
	285/40 R 20	B	A		71
	265/35 ZR 21	C	A		72
	305/30 ZR 21	C	A		73
	265/35 ZR 21	C	A		72
	305/30 ZR 21	C	A		72

For logistical and technical reasons relating to the production process, we are unable to accept orders for a particular make of tyre.

1)  Quiet rolling noise,  Moderate rolling noise,  Loud rolling noise.

I. Range

The ranges determined using the standard WLTP cycle enable comparison between manufacturers. They also include the measuring reach achieved through recuperation (energy recovery during braking). The additionally specified long-distance range provides a guide value for journeys over longer distances. This is based on a partial WLTP cycle that is characteristic of long-distance journeys, allowing for additional auxiliary equipment (e.g. air conditioning). Various factors, such as driving style, traffic situation, topography, speed, use of comfort/auxiliary equipment (e.g. air conditioning, Infotainment, etc.), outside temperature, number of passengers, payload and selected driving mode (e.g. Sport), can have a negative impact on the actual range.

II. Battery

A lithium-ion battery is subject to physical and chemical ageing, as well as wear and tear. This reduces the battery capacity, depending on the usage pattern and environmental conditions, resulting in a reduction in range and an increase in charging times as the battery ages. Due to the effect of temperature on battery and charging performance, as well as battery life, please consider the following when parking, driving and charging your car:

- If possible, avoid permanent ambient temperatures of over 30°C, such as prolonged parking in direct sunlight.
- If you cannot avoid ambient temperatures of over 30°C when stationary, connect the vehicle to the mains supply after use and charge the high-voltage battery with AC (alternating current) to a maximum charge status of 85%.
- If the car is left stationary for more than two weeks, the ambient temperature should, if possible, be between 0°C and 20°C and the battery charge status maintained between 20% and 50% during this time.
- For the shortest possible charging time, a battery temperature of approx. 30°C to 35°C is ideal.
- If charging the car on a daily basis, the maximum charge status of the high-voltage battery should be set to approx. 80%.

III. Charging

The specified charging outputs and times are dependent on various factors: in general, the charging output and time can vary due to physical and chemical limits, depending on factors such as the available output of the country-specific energy infrastructure, the customer's own domestic installation, the temperature, interior pre-conditioning and charging status, as well as the age of the battery. Charging times may therefore be significantly higher than those specified. To achieve the optimum value of the specified DC charging time (DC = direct current) for a charge status increase from 5 to 80%, a CCS (combined charging system) fast-charging pedestal with > 270kW and > 850V is required, as well as a battery temperature of 30°–35°C. The charging status when commencing charging must not exceed 5%. The determination of the specified charging time for a WLTP range of 100km is based on the same prerequisites. For physical and chemical reasons, the charging speed decreases as the battery approaches its full capacity. Therefore, it usually makes sense to use fast DC charging to charge the battery up to 80% or up to the required range. The predominant use of CCS fast-charging pedestals leads to a long-term increase in charging times. For regular fast DC charging, we recommend a maximum charging output of 50kW. When charging in a domestic environment, AC charging (AC = alternating current) is recommended. Using an (AC) industrial electrical outlet will result in improved efficiency and a much shorter charging time compared to using a household socket.

IV. Drive power

In general, the available drive power in battery-operated electric cars depends on various factors, such as the duration of the required performance, as well as the battery voltage and temperature. The specified power is available for at least 10 seconds and the specified overboost with standard launch control for at least 2.5 seconds. Extremely sporty driving or charging at a fast-charging pedestal can result in an increase in battery temperature and, therefore, in temporarily reduced drive power. Due to the physical environment, the maximum power required to achieve the specified acceleration values can be repeatedly produced, but usually not consecutively.

Important information.

د قو ٲٲفاضا ة فل ك لباقم تارا ٲځك ال ة تازٲهڄت ال ضعب رفوتت الو ،ٲٲمانأل ال قوس ال ٲف تاقرط ال حل ع ربس لل ةدمت عم ٲٲتك ال اذ ٲف ةٲٲالم تازارط ال ةن ءرٲٲ ،ٲٲرا ٲځال او ةٲساٲق ال تازٲهڄت ال وء تامول عم حل ع لوصل لل . ةٲل ءمل ا مالكأل او ءوٲقل لل آرظن ءرځ أو قوس نٲٲ تارا ٲځال او تازارط ال رفوت فل تځٲل ءرغش ال ءقل كو ءوقول ك ال هتساو نزول او ءاعبأل او عادأل او مٲمصت ال او تازٲمل او ةٲنل ٲاب ءقل عتمل ا تامول عمل ال ك ةن . كٲل ةل ٲرقأل هشروب زكرم ءراشتسا فل تځت ق .قٲسم راعش ةن ءو ٲل س ال لهؤو تازٲهڄت ال او تافصاومل ال حل ع ال ءءت ءارځل ءء هشروب ظفت تءو . (02/2020) ءعابط ال تقو ٲف ءءٲص ٲه ءرٲٲ ال ءاعل ال ٲاب ءوؤسمل ا ءال ءصوصن حل ع ءالطال ل .امه وءءل ءل ءف نازمآء اظءل او وهسل . ةٲٲالم كلت ن ع ناولأل ال

Os modelos de veículos ilustrados mostram o equipamento para a República Federal da Alemanha. Eles também incluem, p. ex., equipamentos individuais que não fazem parte do fornecimento de série e que estão disponíveis somente com um custo adicional. Devido a determinações e normas específicas dos países, nem todos os modelos ou equipamentos estão disponíveis em diversos países. Informe-se sobre o exato fornecimento no seu Centro Porsche, na sua Concessionária Porsche ou no seu importador. Os dados sobre a estrutura, o fornecimento, a aparência, potência, as medidas, o peso e os custos de operação correspondem ao estado de conhecimento no momento da impressão (02/2020). Reserve o direito a alterações na estrutura, no equipamento e fornecimento, bem como diferenças na cor. Sujeito a erros. Mais informações e o aviso legal em todos os idiomas podem ser encontrados em www.porsche.com/BEV

本手册中介绍的车型已获准在德国的公路上行驶。某些配置项目仅作为额外收费选装配置提供。由于当地条件的制约和各个市场规定的不同，车型和选装配置的供应情况可能会有变化。关于标准和选装配置信息，请咨询当地的保时捷中心。付印时（2020年2月），我们已尽最大努力确保结构、功能、设计、性能、尺寸、重量、耗油量和使用成本等详细信息的准确度。保时捷保留对技术规格、配置和交付范围进行修改的权利，事先恕不另行通知。颜色可能与图示有所差异。保留对错误和遗漏进行修改的权利。如需参考各个语言版本的免责声明，请浏览 www.porsche.com/BEV

Les modèles photographiés dans la présente documentation (caractéristiques et équipements) sont ceux du marché allemand et correspondent aux normes applicables en Allemagne. Ils comportent par exemple des équipements optionnels avec supplément de prix, et certaines versions ou options ne sont pas disponibles dans tous les pays. Pour tout renseignement sur la disponibilité des options et le programme de livraison définitif, veuillez contacter un des Centres Porsche du Réseau Ociel. Les informations fournies ici sur la conception, la livraison, l'aspect extérieur des véhicules, les performances, les dimensions, le poids ainsi que les frais de fonctionnement et d'entretien sont celles disponibles au moment de l'impression (02/2020). Sous réserve de toute modification dans la conception, l'équipement et le programme de livraison, de toute variation de teintes et de matériaux, ainsi que de toute erreur ou omission. Vous trouverez de plus amples informations dans toutes les langues à l'adresse www.porsche.com/BEV

Le vetture raffigurate in queste pagine mostrano gli equipaggiamenti previsti per la Germania. Esse sono parzialmente dotate di equipaggiamenti personalizzati che non fanno parte della dotazione di serie e che vengono forniti con sovrapprezzo. In alcuni Paesi non sono disponibili tutti i modelli e tutti gli equipaggiamenti a causa di vincoli e disposizioni di legge. Per ulteriori informazioni sui modelli e sulla precisa dotazione potete rivolgervi al vostro Partner Porsche o all'importatore. I dati relativi a costruzione, equipaggiamento, forma, prestazioni, dimensioni, peso, consumi e costi di manutenzione delle vetture sono aggiornati al momento della stampa (02/2020). Con riserva di modifiche alla costruzione, all'entità della fornitura e degli equipaggiamenti come pure alla tonalità dei colori. Salvo errori e omissioni. Ulteriori informazioni nella lingua nazionale sono disponibili all'indirizzo www.porsche.com/BEV

このカタログに使用されている写真および記載の諸元、寸法、仕様等は、日本に導入される車両と一部異なる場合があります。またオプション装備品は、日本に導入されないものも含まれます。また、仕様および装備は予告なく変更する場合があります。掲載の写真等の色は実際と異なる場合があります。詳しい装備や仕様については、ボルシェ正規販売店までお問い合わせください。

Modeli prikazani u ovom izdanju odobreni su za upotrebu na cestama u Njemačkoj. Neki dijelovi opreme dostupni su samo uz dodatnu nadoplatu. Dostupnost modela i mogućnosti može se za različita tržišta razlikovati uslijed lokalnih ograničenja i propisa. Za informacije o standardnoj i dodatnoj opremi obratite se svome Porsche centru. Svi podaci o konstrukciji, značajkama, dizajnu, performansama, dimenzijama, masi, potrošnji goriva i troškovima održavanja prema našim su saznanjima točni u trenutku odlaska u tisak (02/2020). Porsche zadržava pravo na izmjenu specifikacija, opreme i opsega isporuke bez prethodne obavijesti. Boje se mogu razlikovati od prikazanih. Pogreške i propusti isključeni. Izjavu o ograničenju odgovornosti na svim jezicima potražite na adresi www.porsche.com/BEV

Šiame leidinyje pateikti modeliai yra patvirtinti naudoti keliuose Vokietijoje. Kai kurios įrangos dalys yra prieinamos tik papildomai apmokant. Dėl vietinių apribojimų ir taisyklių galimi modeliai ir pasirinkimai gali skirtis priklausomai nuo rinkos. Norėdami sužinoti apie standartinę ir papildomą įrangą, kreipkitės į savo „Porsche“ centrą. Visa informacija apie konstrukciją, savybes, dizainą, eksploatacines savybes, matmenis, svorį, degalų sąnaudas ir eksploatacines išlaidas yra teisinga, kiek mums žinoma, ją ruošiant spausdinti (02/2020). „Porsche“ pasilieka teisę be išankstinio įspėjimo keisti specifikacijas, įrangą ir pristatymo apimtis. Spalvos gali skirtis nuo pateiktų iliustracijose. Išimtos klaidos ir praleidimai. Atsakomybės apribojimas visomis kalbomis pateikiamas svetainėje www.porsche.com/BEV

Моделите опишани во ова издание се одобрени за употреба на патишта во Германија. Некои ставки од опремата се достапни само како опции со дополнителен трошок. Достапноста на моделите и опциите може да се разликува во зависност од пазарот поради локалните ограничувања и прописи. За информации околу стандардната и изборната опрема, советувајте се со Porsche центарот. Сите информации во врска со конструкцијата, функциите, дизајнот, перформансите, димензиите, тежината, потрошувачката на гориво и трошоците за одржување се точни според нашите најдобри сознанија во времето на печатењето (02/2020). Porsche го задржува правото да ги измени спецификациите, опремата и опсезите на испорака без претходно известување. Боите може да се разликуваат од тие на сликите. Грешките и пропустите се исклучени. За одрекувањето од одговорност на сите јазици, погледнете во www.porsche.com/BEV

Modele przedstawione w niniejszej publikacji zostały dopuszczone do użytku drogowego. Niektóre elementy wyposażenia są opcjonalne i dostępne wyłącznie za dodatkową opłatą. Ze względu na lokalne przepisy i ograniczenia dostępność danych modeli i opcji na poszczególnych rynkach może być różna. Aby uzyskać więcej informacji na temat wyposażenia standardowego i opcjonalnego, najlepiej skontaktować się z najbliższym Porsche Centrum. Wszystkie informacje dotyczące konstrukcji, właściwości, stylistyki, osiągnięć, wymiarów, mas, zużycia paliwa i kosztów eksploatacji są, zgodnie z naszą najlepszą wiedzą, prawidłowe w momencie ich opublikowania (02/2020). Porsche zastrzega sobie prawo do zmiany specyfikacji oraz zakresu wyposażenia i dostaw bez uprzedzenia. Rzeczywiste kolory mogą się różnić od kolorów przedstawionych na ilustracjach. Zastrzega się prawo do błędów i pominięć. Więcej informacji w poszczególnych językach zamieszczamy na stronie www.porsche.com/BEV

Modely uvedené v tejto publikácii sú schválené pre premávku na cestných komunikáciách v Nemecku. Niektoré položky výbavy sú k dispozícii iba za príplatok. Dostupnosť modelov a prvkov výbavy sa môže v jednotlivých krajinách líšiť z dôvodu miestnych obmedzení a nariadení. Pre viac informácií o štandardnej a doplnkovej výbave sa obráťte na vaše Porsche Centrum. Všetky informácie týkajúce sa konštrukcie, funkcií, dizajnu, výkonnosti, rozmerov, hmotností, spotreby paliva a prevádzkových nákladov sú podľa našich najlepších znalostí správne v čase odoslania do tlače (02/2020). Spoločnosť Porsche si vyhradzuje právo na zmeny špecifikácií, výbavy a dodania bez predchádzajúceho upozornenia, takisto aj právo na chyby a odchýlky. Farby sa môžu líšiť od tých, ktoré sú vyobrazené. Dokument Zrieknutie sa zodpovednosti v požadovanom jazyku si môžete pozrieť na adrese www.porsche.com/BEV

Los modelos de automóviles mostrados en esta publicación están aprobados para su circulación en la República Federal Alemana. La disponibilidad de los modelos, así como el equipamiento ofertado puede variar de un país a otro debido a razones legales y/o regulaciones de carácter local. Para obtener información sobre los modelos y el equipamiento estándar y/u opcional disponible en su país, consulte en su Centro Oficial Porsche. Toda la información relacionada con la fabricación, características, diseño, prestaciones, dimensiones, peso, consumo de combustible y costes de mantenimiento de los automóviles mostrados responden a los datos actualizados en la fecha de impresión del presente documento (02/2020). Porsche se reserva el derecho de realizar modificaciones en las especificaciones, equipamiento y las condiciones de entrega de los automóviles mostrados en esta publicación sin previo aviso. Debido a la técnica de impresión, los colores reales de los automóviles podrían diferir de los mostrados en la presente publicación. Está prohibida la reproducción, en cualquier forma o por cualquier método, de la totalidad o de una parte de esta publicación sin la autorización por escrito de Dr. Ing. h.c. F. Porsche AG. Para acceder a esta publicación en otros idiomas, por favor consulte: www.porsche.com/BEV

Modelele din această publicație sunt omologate pentru șoselele din Germania. Unele echipamente sunt disponibile doar opțional, contra cost. Disponibilitatea modelelor și opțiunile pot varia de la piață la piață din cauza restricțiilor și reglementărilor locale. Pentru informații privind echipamentele standard și cele opționale, consultați Centrul dvs. Porsche. Toate informațiile privind construcția, caracteristicile, designul, performanțele, dimensiunile, greutatea, consumul de combustibil și costurile de funcționare sunt corecte la momentul tipăririi (02/2020). Porsche își rezervă dreptul de a modifica specificațiile, echipamentele și termenul de livrare fără notificare prealabilă. Culoarele pot fi diferite de cele ilustrate. Erorile și omisiunile sunt exceptate. Pentru precizări legale în fiecare limbă, consultați www.porsche.com/BEV

Описанные модели автомобилей представлены в комплектации для Германии. Данные варианты комплектации включают в себя дополнительное оборудование, которое не входит в базовую комплектацию и предлагается только за дополнительную плату. В различных странах вследствие особых норм и правил предлагаются не все модели и, соответственно, варианты комплектации. За более подробной информацией обратитесь к официальным дилерам Porsche. Сведения о конструкции, объеме поставки, внешнем виде, мощности, габаритах, массе и эксплуатационных расходах действительны на момент подписания материала в печать (02/2020). Возможны изменения в конструкции, комплектации и объеме поставки, а также различия цветовых оттенков и ошибки. Прочую информацию на Вашем языке Вы найдете на www.porsche.com/BEV

Bu katalogta yer alan modeller Almanya'daki sürüş koşullarına göre test edilerek onaylanmıştır. Bazı donanımlar ekstra ücrete tabi opsiyonel seçenekler olarak sunulmaktadır. Mevcut modeller ve donanım seçenekleri, yerel sınırlamalar ve düzenlemelere bağlı olarak ülkeler arasında farklılık gösterebilir. Standart ve opsiyonel donanımlara ilişkin bilgi için lütfen Porsche Merkezleri ile iletişim kurun. Tüketim, özellikler, tasarım, performans, boyutlar, ağırlık, yakıt tüketimi ve bakım masrafları ile ilgili tüm bilgiler, bu katalogun basıldığı tarihteki bilgiler ile hazırlanmıştır (02/2020). Porsche, önceden bildirimde bulunmaksızın spesifikasyonları, donanım özelliklerini ve teslimat kapsamını değiştirme hakkını saklı tutar. Hata ve ihmaller hariç, renkler resimlerde görülen renklere farklılık gösterebilir. Her dildeki yasal bildiri için lütfen www.porsche.com/BEV adresini ziyaret edin.

© Dr. Ing. h.c. F. Porsche AG, 2019

All text, images and other information in this catalogue are subject to the copyright of Dr. Ing. h.c. F. Porsche AG.

Any reproduction, duplication or other use is prohibited without the prior written consent of Dr. Ing. h.c. F. Porsche AG.

Dr. Ing. h.c. F. Porsche AG supports the use of paper from sustainable forests. The paper for this sales brochure is certified in accordance with the strict regulations of the FSC® (Forest Stewardship Council®).

Porsche, the Porsche Crest, Taycan, PCCB, PCM, PSM, Tequipment and other marks are registered trademarks of Dr. Ing. h.c. F. Porsche AG.

Dr. Ing. h.c. F. Porsche AG
Porscheplatz 1
70435 Stuttgart
Germany
www.porsche.com

Effective from: 10/2019
Printed in Germany
WSLT1901000284 EN/WW